



**Henan weilebao Maternal And Child Products Co., Ltd**  
Meijing Guanlanhu Residential Community  
Chengguan Town, Linying County, Luohe City  
Henan Province, China

company 24 online: 4006219993  
whatsapp :+8618339593880  
Email: sales@welebao.com



 welebo®



# CATALOGUE

## BABY STROLLER

2026NEW



A close-up photograph of a hand holding a baby's foot, with a white logo and text overlaid. The background is a soft, textured white fabric, possibly a blanket or bedsheet. The hand is positioned in the center, with the fingers gently holding the baby's foot. The lighting is warm and soft, creating a gentle and intimate atmosphere. The logo consists of a stylized heart shape with a checkmark inside, followed by the word "welebo" in a lowercase, sans-serif font. Below this, the phrase "WE LOVE BABY" is written in all caps, flanked by two horizontal lines.

 welebo

WE LOVE BABY

# ABOUT

# US

**Henan Weilebao Maternal and Child Products Co., Ltd. specializes in one-stop solutions for safe baby travel. With 10 years of experience in the maternal and child industry (since 2017) and over a decade of mature service expertise, our company integrates R&D, production, sales, and service. We run modern, standardized production with full lines and strict QC.**

Our company provides ODM (original design manufacturing) and OEM (original equipment manufacturing) services and holds 64 professional certificates in the industry. All products are certified to international standards such as EN1888, ASTM, and 3C, fully complying with EN, CE, ASTM, and other global quality requirements. We can also cooperate with customers to make certificates that can meet the local standards. Now our strollers have good sales performance in national market with Sales revenue of RMB 230 million. Whether selecting the current products from our catalogs or designing according to your own design, we ensure the excellent performance. Meanwhile We offer you the following professional services: short lead time (20–25 days for mass production), free design support, OEM/ODM service, free packaging for full container orders, and reliable after-sales service.

Our products sell to China, North America, Russia, Europe, Australia, and Southeast Asia, partnering with 50+ distributors in 70+ cities over the past 10 years. We offer cost-effective pricing, pre-order samples, and responsive service—welcome global inquiries.



 **welebo**



Quality



Factory



OEM&ODM



Fast Delivery



Service



Team

# WHY CHOOSE

# US

# Welebo · China's Top Stroller Brand

200M+ Annual Sales · Leading Supply Chain Integrator



## OUR FACTORY

Established in 2008  
Factory area 10000m



## PATENT

Invention patents:8  
Work new utility:58  
Appearance patents:65

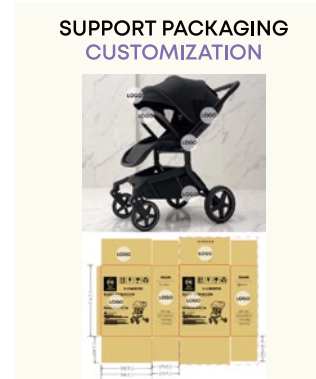

## OEM&ODM

Excellent customization  
service



## BEST QUALITY SUPPORT

Strictest quality control  
ECE&CCC homologations  
in laboratory





OEM/ODM

Professional  
Manufacturer

**+15 YEARS**  
**Baby stroller**

Of production and export experience

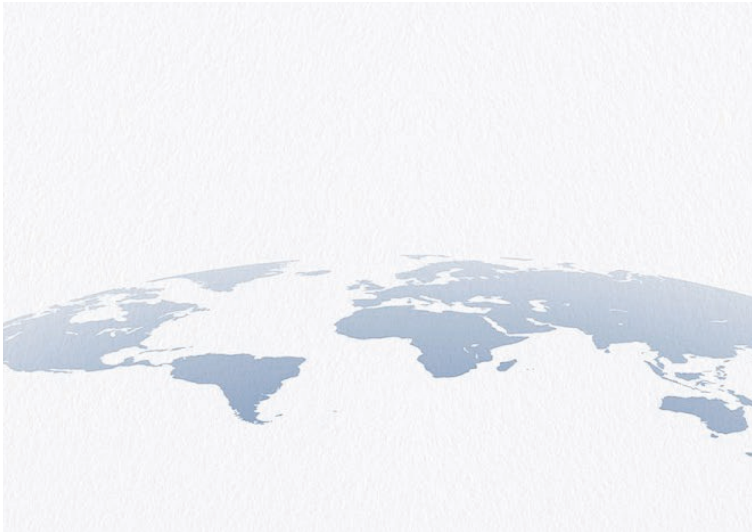

**30 YEARS**  
**Focused on baby products**

Our factory is professional on OEM and ODM to make your idea come true.





CERTIFICATE



LIND+JUGEND-INTERNATIONAL  
BABY TO COLOGNE



CHINA IMPORT AND  
EXPORT FAIR



CHINA BABY-MATERNAL  
-CHILD EXPO



HKTDC BABY PRODUCTS  
/TOY FAIR

# EXHIBITION

## Q7 High-Vision Baby Stroller

### Specification

#### Item

Model  
Suitable  
Fabric  
Frame  
Wheel  
Material  
N.W./G.W.  
Carton size  
Container Loading Capacity  
Certificate

#### Details

Q7  
0-3 years old  
Polyester  
Aluminum Alloy  
Polyurethane  
Aluminum Alloy, Plastic, Polyester, Polyurethane  
7.5kg/9.6kg  
53x70.5x34cm  
20GP:230 units; 40HC:525 units  
EN1888, ASTM, ISO, TUV



## Feature Description

- Steel frame
- 300D linen or figured fabric
- 26 PU universal front wheels with suspension
- 28 PU rear wheels with one-touch brake and suspension
- One-hand folding device
- Two-way push
- 3 position adjustable backrest
- 5-point safety belt
- Removable thick lycra pad
- EVA handle
- Large storage basket
- Suitable for 0-36 months baby

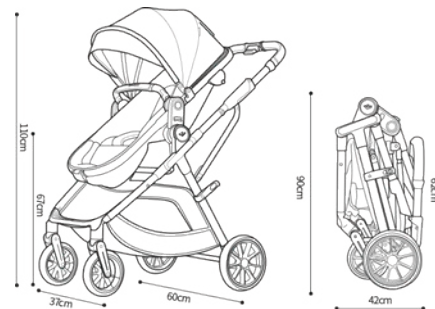

White base image  
Other colour available



# LINGYUE

## 936S Double Push Rod Stroller

### Specification

#### Item

Model/Product Code  
Suitable  
Fabric  
Frame  
Wheel  
N.W./G.W.  
Carton size  
Container Loading Capacity  
Certificate

#### Details

936S  
0-3 years old  
Polyester  
Aluminum Alloy  
Polyurethane  
7.9kg/9.9kg  
51.5×65×29cm  
20GP:264 units; 40GP:552 units; 40HC:621 units  
EN1888, ASTM, ISO, TUV



## Feature Description

- Aluminum alloy frame
- Premium leather fabric
- 360 universal front wheels
- Rear wheels with one-touch brake
- One-hand easy folding device
- Portable & lightweight design
- High landscape stroller structure
- 5-point safety belt
- Comfortable leather seat pad
- EVA handle
- Large storage basket
- Suitable for 6-72 months (0-3 years)



White base image  
Other colour available



# D900

## Double Rod Reversible Baby Stroller

### Specification

#### Item

Model/Product Code  
Suitable  
Fabric  
Frame  
Wheel  
N.W./G.W.  
Carton size  
Container Loading Capacity  
Certificate

#### Details

D900  
0-3 years old  
Polyester  
Aluminum Alloy  
Polyurethane  
8.9kg/11.5kg  
51.5×65×29cm  
20GP:264 units; 40GP:552 units; 40HC:621 units  
EN1888, ASTM, ISO, TUV



## Feature Description

- Aluminum alloy frame
- Reversible & height-adjustable handlebar
- 5-point safety belt to hold your baby securely
- One-hand folding & self-standing after folding
- Removable, shock-proof & 360° rotating wheels
- Wheels with linked one-touch brake
- Removable bumper & 3-position adjustable footrest
- 4-position seat reclining
- Large shopping box
- Large newborn carrycot
- The seat has a winter padded Comfort Cover
- Summer breathable mesh backrest for laid flat

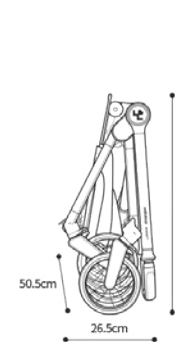
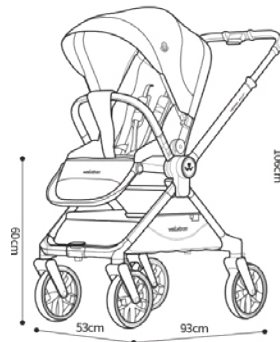

White base image  
Other colour available



# PC900

## JINGLING Baby Stroller Feature Description

### Specification

#### Item

Model  
Suitable  
Fabric  
Frame  
Wheel  
N.W./G.W.  
Carton size  
Container Loading Capacity  
Certificate

#### Details

PC900  
0-3 years old  
Oxford cloth (UPF50+)  
Aluminum alloy  
Rubber  
Stroller: 8.75kg/11kg; Carrycot: 4.1kg/5.3kg  
Stroller: 53x34x70.5cm; Carrycot: 45x17x91cm  
40HQ Stroller: 547pcs; Carrycot: 47pcs  
EN1888, ASTM, ISO, TUV



## Feature Description

Sturdy Aluminum Alloy Frame

0-3yrs All-Age Fit: Grows with baby from newborn to toddler

Spine-Protective Backrest

One-Click Bidirectional Fold

4-Wheel Shock Absorption

3-Level Backrest Adjustment

Spacious Storage: extra large under-seat basket

UPF50+ Sun Canopy: Full coverage blocks UV rays effectively

15kg Max Load: Safe, reliable weight capacity for daily use

5-Point Safety Harness

Durable Polyester Fabric

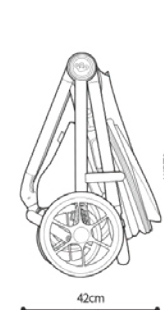

# A7 Lightweight Baby Stroller

## Specification

### Item

Model  
Suitable  
Fabric  
Frame  
Wheel  
N.W./G.W.  
Carton size  
Container Loading Capacity  
Certificate

### Details

A7  
Suitable for 6-36 months baby  
Polyester  
Aluminum Alloy  
Polyurethane  
5.9kg/6.9kg  
42x54x32 cm  
20GP:392pcs; 40GP:784pcs; 40HC:896pcs  
EN1888, ASTM, ISO, TUV



## Feature Description

- Lightweight Aluminum Frame
- Compact Carton Size: 42x54x32cm, ideal for storage & shipping
- High-Efficiency Loading: 20GP/392, 40GP/784, 40HC/896 units
- 0-3yrs All-Age Fit: Grows with baby from newborn to toddler
- Spine-Protective Backrest: Integrated ridge support
- One-Click Folding: Easy one-hand operation
- 4-Wheel Shock Absorption
- 3-Level Seat Adjustment
- UPF50+ Sun Canopy
- 5-Point Safety Harness

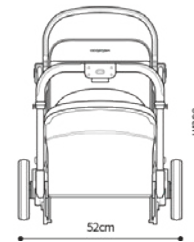

White base image  
Other colour available



# WTO6

## Gravity auto-folding

### Specification

#### Item

Model  
Brand  
Fabric  
Weight Capacity  
Suitable Age  
Folded Size  
Carton size  
Stroller Weight  
40HQ

#### Details

WTO6  
WEILEBAO  
Eco-Friendly Honeycomb Mesh  
15 kg (National Standard)/ 22 kg  
0-4 Years  
22 \*48\*52 cm  
43\*53\*20cm  
4.3 kg  
1305



## Feature Description

Ultra-lightweight (only 4.3kg) and compact for easy travel  
 One-hand automatic folding for hassle-free use  
 Ergonomic hard back support to protect baby's spine  
 Smooth, quiet ride with car-grade steel dual axles  
 4-wheel independent suspension for all-terrain comfort  
 Extra-wide, flat seat (36cm) suitable for bigger babies  
 UPF50+ adjustable canopy blocks sun, wind, and UV rays  
 2-in-1 fabric design for year-round use  
 Secure 5-point safety harness  
 Large under-seat basket and side pocket for essentials  
 One-step dual brake for instant, safe stops

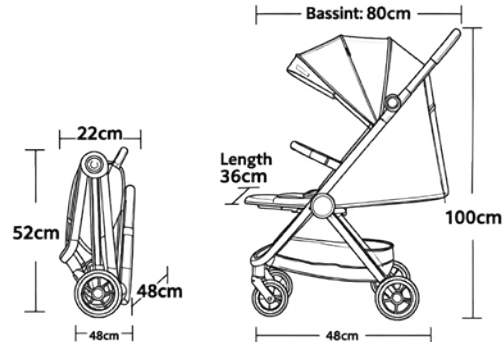

White base image  
 Other colour available



# QINGLING-AIR

## 2-in-1 baby stroller

### Specification

#### Item

Model  
 Suitable  
 Fabric  
 Frame  
 Wheel  
 Other Components  
 Includes  
 N.W./G.W.  
 Carton size  
 Container Loading Capacity  
 Certificate

#### Details

QINGLING-AIR  
 6-72 months  
 Polyester  
 Aluminum Alloy  
 Polyurethane  
 Plastic  
 Stroller + Bassinet  
 7.8kg/9.8kg  
 70x75x50 cm  
 20GP:96 units; 40GP:204units; 40HC:255units  
 EN1888, ASTM, ISO, TUV



## Feature Description

- Aluminum alloy frame
- Reversible & height-adjustable handlebar
- 5-point safety belt to hold your baby securely
- One-hand folding & self-standing after folding
- Removable, shock-proof & 360° rotating wheels
- Wheels with linked one-touch brake
- Removable bumper & 3-position adjustable footrest
- 4-position seat reclining
- Large shopping box
- Large newborn carrycot
- The seat has a winter padded Comfort Cover
- Summer breathable mesh backrest for laid flat



White base image  
Other colour available



# HANGTIANIHAO Car Safety Seat

## Specification

### Item

Model  
Suitable  
Fabric/Material  
N.W/G.W.  
Carton size  
Container Loading Capacity  
Certificate

### Details

HANGTIANIHAO  
9 Months-12 Years  
EPP, Memory Foam  
14.9kg/16.8kg  
57x46x61cm  
20GP:150 units; 40GP:315 units; 40HC:420 units  
EN1888, ASTM, ISO, TUV



## Core Selling Points

ECE R44/04 certified, professional in-vehicle child safety  
 Fit 9m-12y kids, max load 36kg, multi-weight grade adaptation  
 High-impact EPP+memory foam+aluminum alloy frame  
 5-point adjustable harness, all-round safety  
 360° rotating base (NEXT compatible), one-motion easy operation  
 Button-adjustable headrest, fits kids' growth stage  
 Non-toxic washable fabric, full OEM/ODM customization support



Racing grade duckle system

Adjustable headrest

Surrounding handle

Foldable support legs

About 0-4 years old

About 15 months to 4 years old

About 3-12 years old

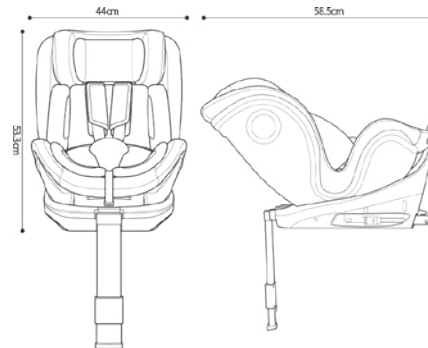

White base image  
 Other colour available



# A8-BR2

## Tool-Free Installation Bed Rail

### Specification

#### Item

Model  
Suitable  
Fabric  
Frame  
Wheel  
Other Components  
N.W./G.W.  
Carton size  
Container Loading Capacity  
Certificate

#### Details

A8-BR2  
6-72months  
Oxford Fabric  
Steel Tube  
EVA Foam  
Plastic  
4kg/6.5kg  
28x81x12cm  
20GP:798units; 40GP:1596units; 40HC:1848units  
EN1888, ASTM, ISO, TUV



## Feature Description

Lightweight Aluminum Frame

Compact Carton Size: 42x54x32cm, ideal for storage & shipping

High-Efficiency Loading: 20GP/392, 40GP/784, 40HC/896 units

0-3yrs All-Age Fit: Grows with baby from newborn to toddler

Spine-Protective Backrest: Integrated ridge support

One-Click Folding: Easy one-hand operation

4-Wheel Shock Absorption

3-Level Seat Adjustment

UPF50+ Sun Canopy

5-Point Safety Harness

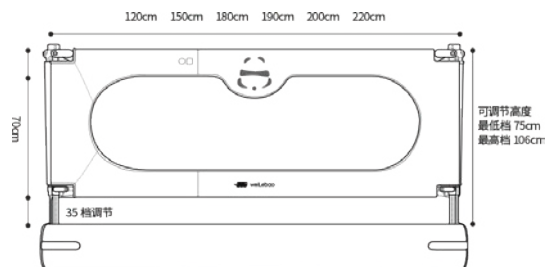

White base image  
Other colour available



# XQY-HSC

## Baby Hip Seat Carrier

### Specification

#### Item

Model  
Suitable  
Fabric  
N.W./G.W.  
Carton size  
Container Loading Capacity  
Certificate

#### Details

XQY-HSC  
6-72months  
100% Polyester  
1.8kg/2.8kg  
27x20x27 cm  
20GP:1,848 units; 40GP:3,872 units; 40HC:4,356 units  
EN1888, ASTM, ISO, TUV



## Feature Description

8-point spine protection & 7.5cm M-shaped seat  
 FitGo one-touch knob, one-hand precise tightening  
 C-section friendly core + 3D skin-friendly fabric  
 V-shaped widened breathable shoulder straps  
 Dual safety lock + seamless anti-pinch design  
 Full-stage carrying positions (horizontal/front/back)  
 Lightweight (<1kg) & portable

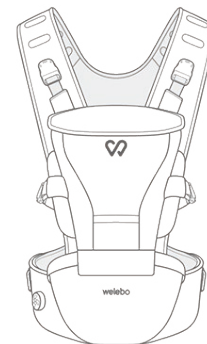
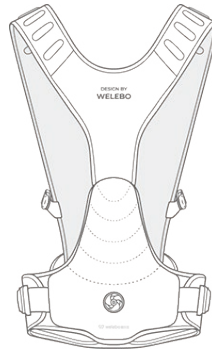

White base image  
 Other colour available





elebo®

